

18U
4113

**Toyota ProAce, Peugeot Expert,
Citroen Jumpy, Md. 2016
Peugeot Traveller Md. 2019
Opel Vivaro Md. 2020**

EU-Personenschutzbügel 60 mm

EU-Pedestrian Protection Bar 60 mm

Protection avant, homologuée CEE, 60 mm



ASSEMBLY INSTRUCTION

Montageanleitung • Instructions de montage

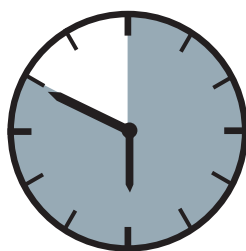

50 Minuten

article no.:

18U4113 (S) inox

18U5113 black steel

Revision 8: 30.09.2021



M6 (A2):
8,8 Nm
M8 (A2):
21,4 Nm
M8:
25 Nm
M6:
2Nm

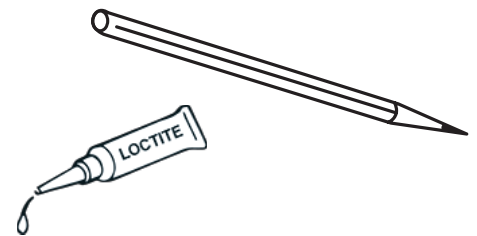
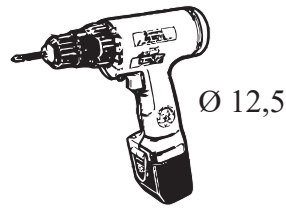

18U4113.1 / 18U5113.1

mounting kit: 18U9113

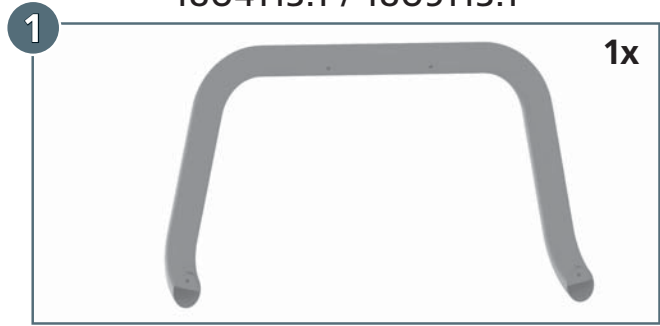

	M6x20 (25); ähnl.ISO 7380 A2	2x
	M6x25; DIN 933 Zn	2x
	M8x30; DIN 933 Zn	2x
	M8x25; DIN 933 A2	2x
	M8; DIN 934 Zn	4x
	Ø 6,4; DIN 9021 A2	2x
	Getowell M6	2x
	SW 10	2x
	SW 13	2x
	Ø 6,4; DIN 9021 Zn	2x

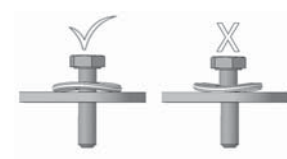
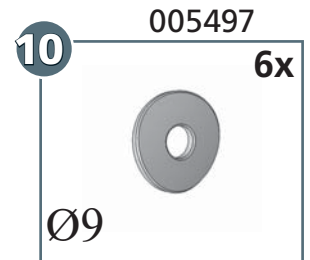
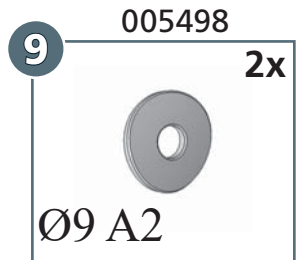
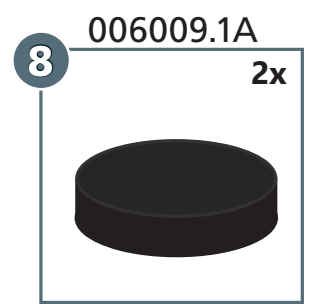
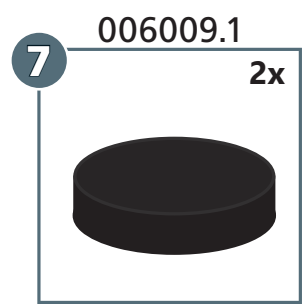
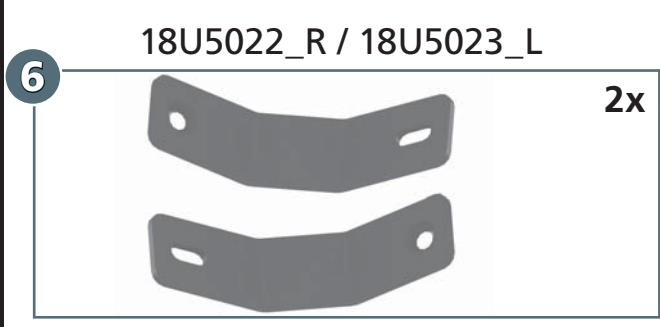
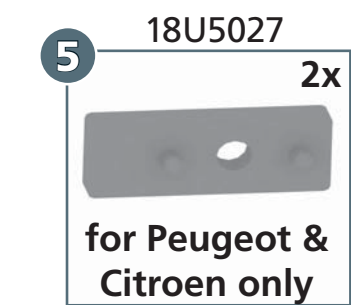
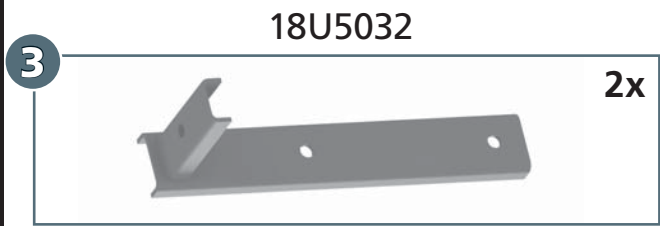
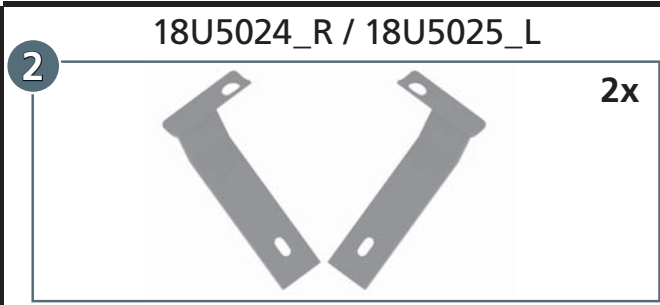

article no.:
18U4113 (S) inox
18U5113 black steel

Revision 8: 30.09.2021



