

**17H
4013**

Ford Tourneo / Transit Courier, Md. 06/2014

EU-pedestrian protection bar 60 mm with cross pipe 42 mm
EU-Personenschutzbügel 60 mm mit integriertem Querrohr 42 mm
Protection avant, homologuée CEE, 60 mm, traverse 42 mm



ASSEMBLY INSTRUCTION

Montageanleitung • Instructions de montage

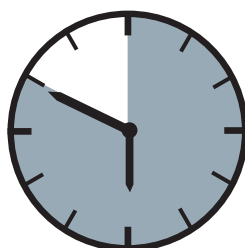

50 Minuten

article no.:
17H4013 (S) inox
17H5013 black steel

Revision 2: 06.06.2019



M8(A2):
21,4 Nm
M8:
25 Nm
M8 A*:
5 Nm
M6:
2Nm

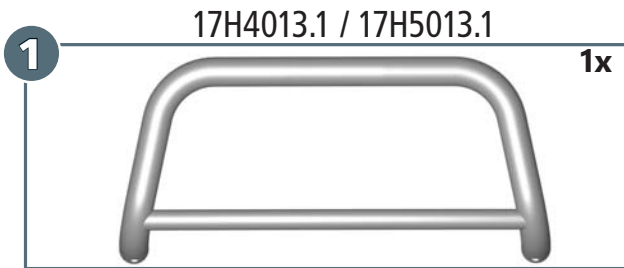
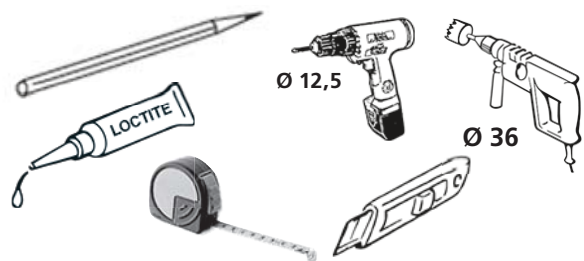
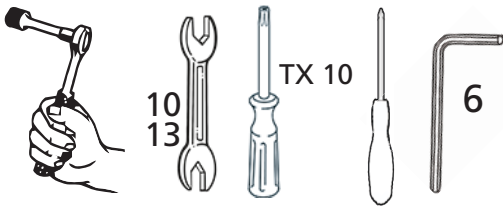



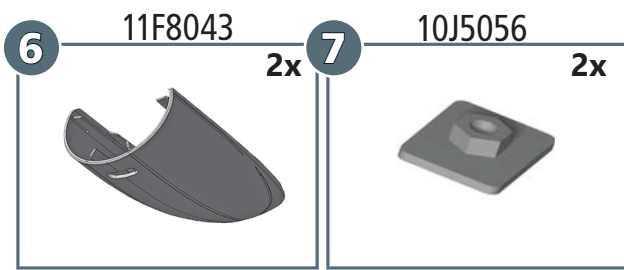
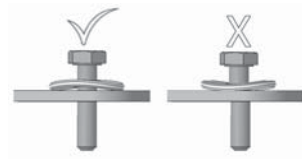
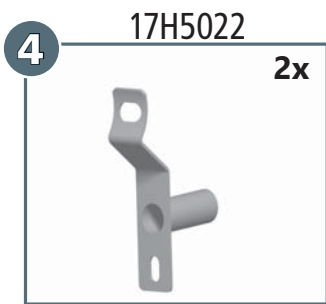
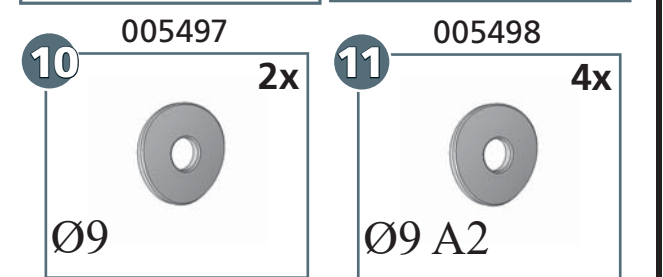
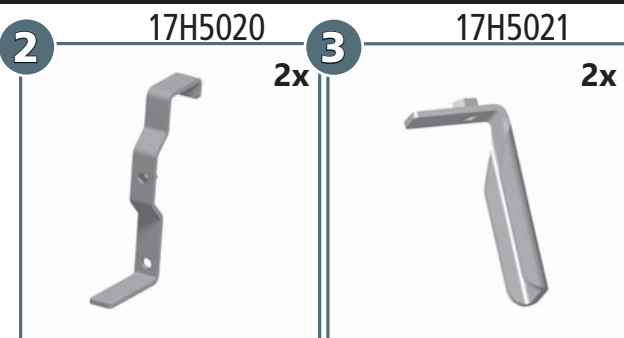
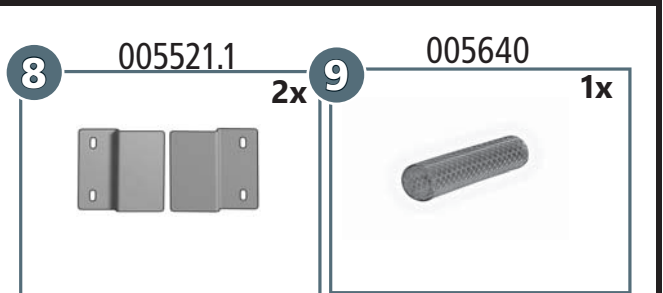







mounting kit: 17H9013

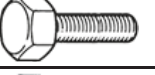
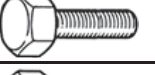
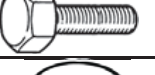

article no.:
17H4013 (S) inox
17H5013 black steel

Revision 2: 06.06.2019



	M8 x 65; DIN 912 Zn	4x
	M8 x 30; DIN 912 A2	2x
	M8 x 25; DIN 933 A2	2x
	M6 x 25; DIN 933 Zn	2x
	M8 x 50; DIN 933 Zn	2x
	Ø 8,4; DIN 125 Zn	4x
	Ø 6,4; DIN 9021 Zn	2x
	Getowell M6	2x
	Ø 4,2; DIN 9021 A2	2x
	Ø 5,3 DIN 9021 A2	4x
	SW 13	2x
	Ø 4,8 x 19; DIN 7981 A2	4x
	Ø 3,5 x 13; ähnl. DIN 7981 A2	2x

article no.:
 17H4013 (S) inox
 17H5013 black steel

Revision 2: 06.06.2019



