

**15V**  
**4213NC**

## Ford Ranger; Md. 2023

EU-Pedestrian Protection Bar 76 mm with cross pipe 51 mm  
EU-Personenschutzbügel 76 mm mit Querrohr 51 mm  
Protection avant, homologuée CEE, 76 mm, traverse 51 mm

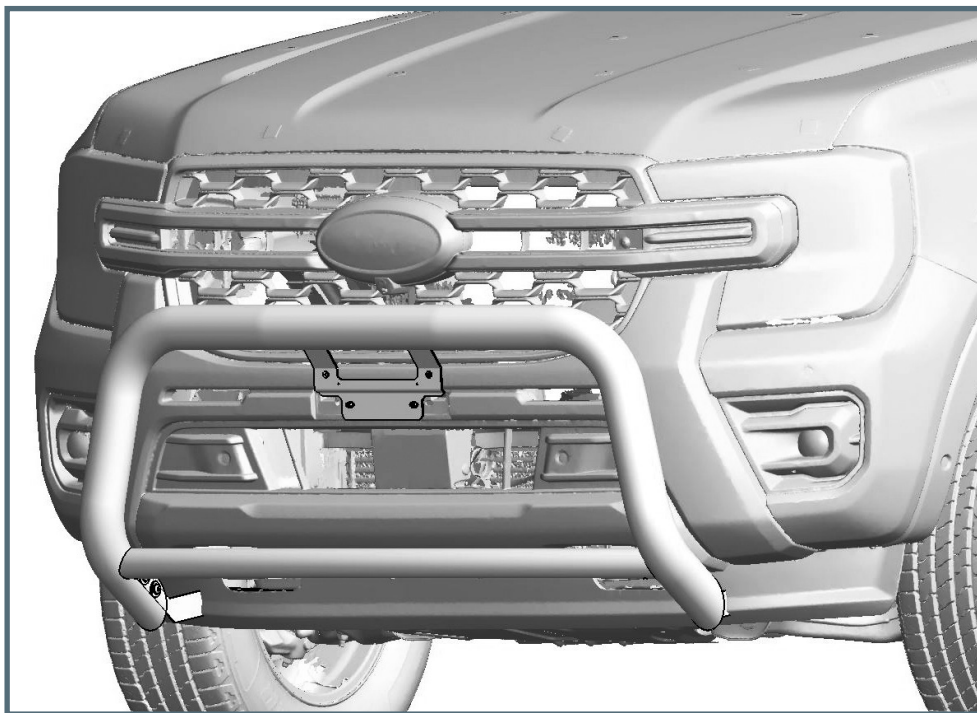

# ASSEMBLY INSTRUCTION

Montageanleitung • Instructions de montage

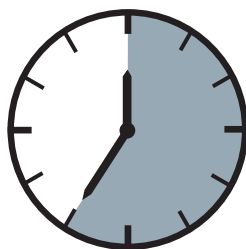

35 Minuten

article no.:

15V4213NC (S) inox

15V5213NC black steel

Revision 2: 05.02.2024



M6(A2):  
8,8 Nm  
M8 (A2):  
21,4 Nm  
M8 (Zn):  
25 Nm

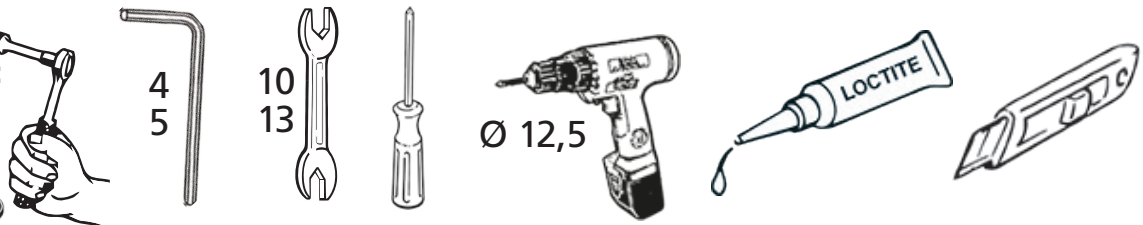

M6:  
2 Nm

15V4213.1C(S) / 15V5213.1C



mounting kit: 15V9313NC

22K5046C\_R / 22K5047C\_L

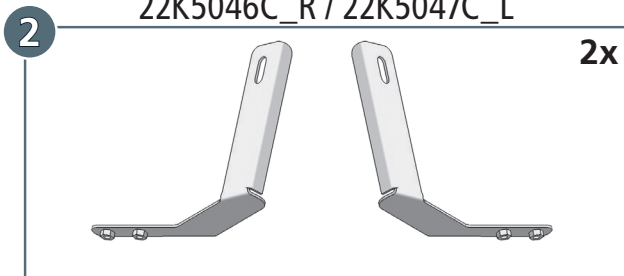

22K5048

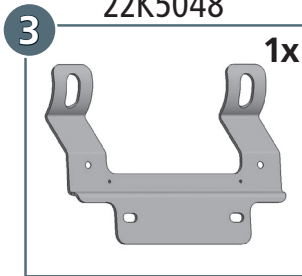

22K5022

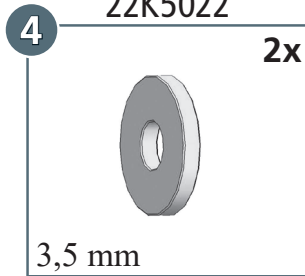

3,5 mm

005498

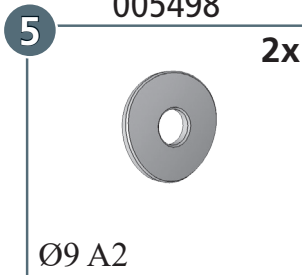

Ø9 A2

005497

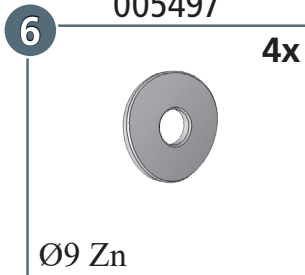

Ø9 Zn

006009.1

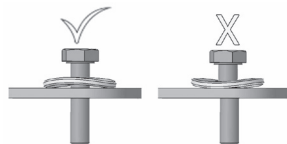
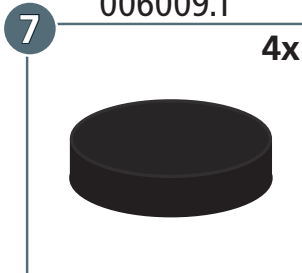

	M8x30; DIN 933 A2	2x
	M6x25; DIN 933 A2	2x
	M6x25; DIN 7991 A2	2x
	M8x20; ähnl. ISO 7380 Zn	4x
	Ø6,4; DIN 9021 A2	2x
	GETO-WELL M6	4x
	SW 13	2x
	Ø4,8x19; DIN 7981C A2	2x
	Ø5,3; DIN 9021 A2	2x

article no.:

15V4213NC (S) inox

15V5213NC black steel

Revision 2: 05.02.2024



