

# Toyota Urban Cruiser; Modell 2009

Spoiler Protection Pipe 42 Front straight / Spoilerschutzrohr 42 gerade



## FITTING INSTRUCTIONS

Montageanleitung • Instructions de montage  
Instrucctionnes de montaje • Manual

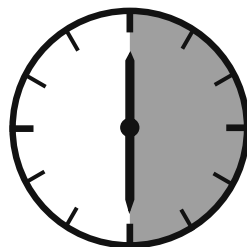

30 Minuten

### Artikel-Nr:

14N 4016 Stainless Steel  
14N 5016 Steel black  
14N 9016 Mounting Set

Revision I: 20.01.2010



# Toyota Urban Cruiser; Modell 2009

Spoiler Protection Pipe 42 Front straight / Spoilerschutzrohr 42 gerade

## Required tools / Benötigte Werkzeuge / Outillage requis / Herramientas necesarias

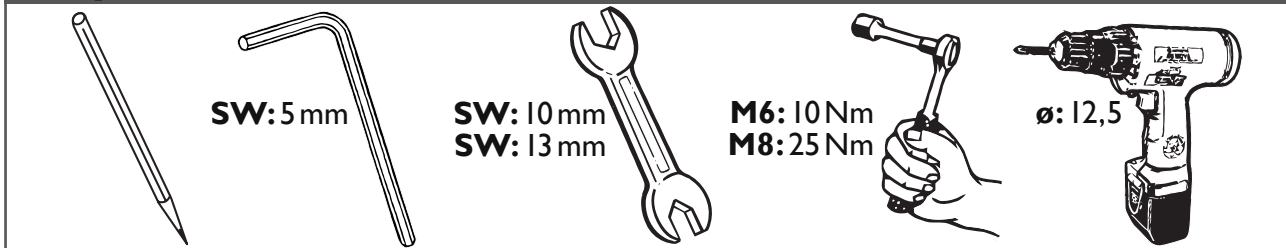

## Parts list / Teileliste / Lista de accesorios



## Mounting set I4N9016 / Montagesatz I4N9016

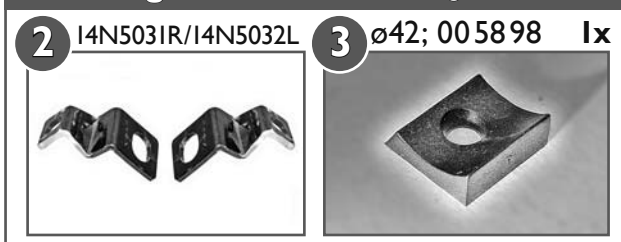

## Standard Parts list / Normteilleiste

<b>a</b>		M6x25; DIN 933	2x
<b>b</b>		M6x30; DIN 912	1x
<b>c</b>		M8x20; DIN 933	2x
<b>d</b>		M6; GETO-WELL	1x
<b>e</b>		ø6; DIN 127	2x
<b>f</b>		ø8; DIN 127	2x
<b>g</b>		ø6,4; DIN 9021	2x
<b>h</b>		ø8,4; DIN 9021	2x

### Artikel-Nr:

I4N 4016 Stainless Steel  
I4N 5016 Steel black  
I4N 9016 Mounting Set

Revision I: 20.01.2010

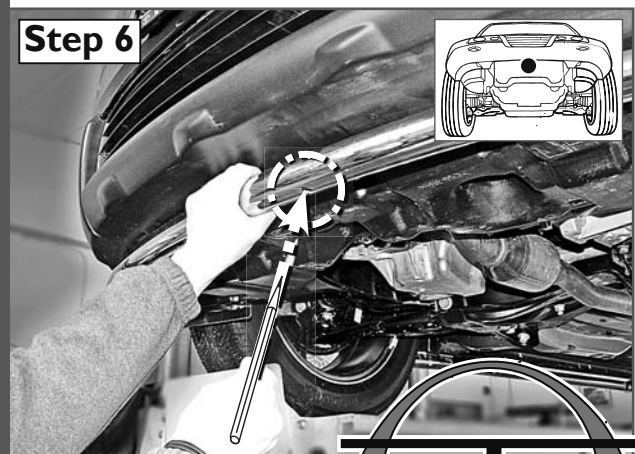
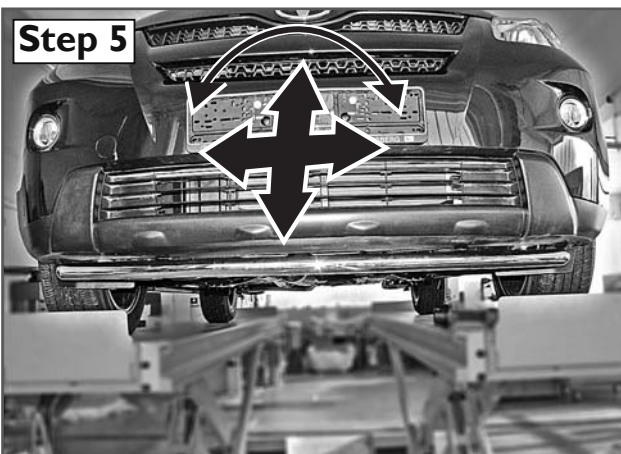
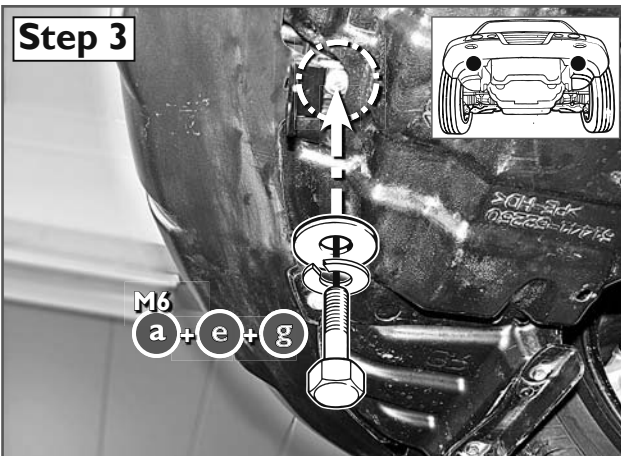
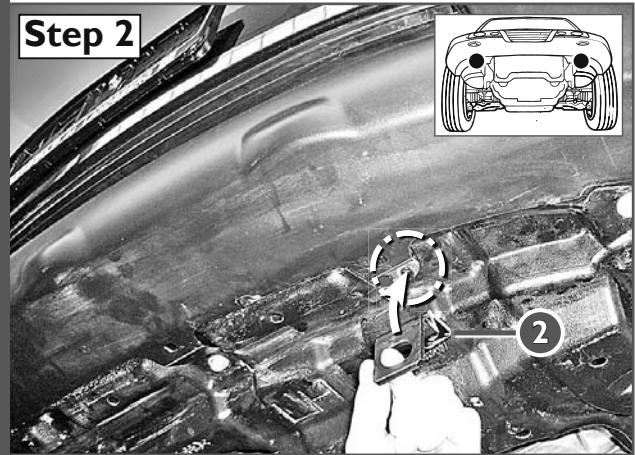
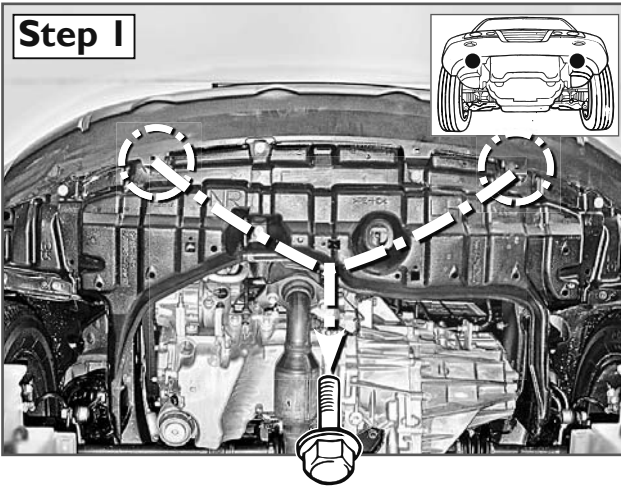



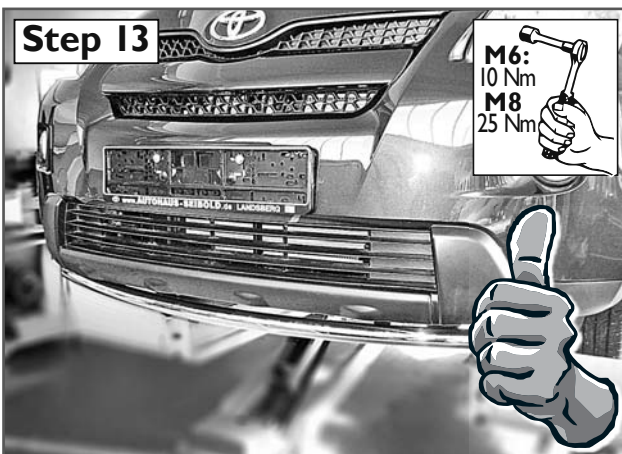
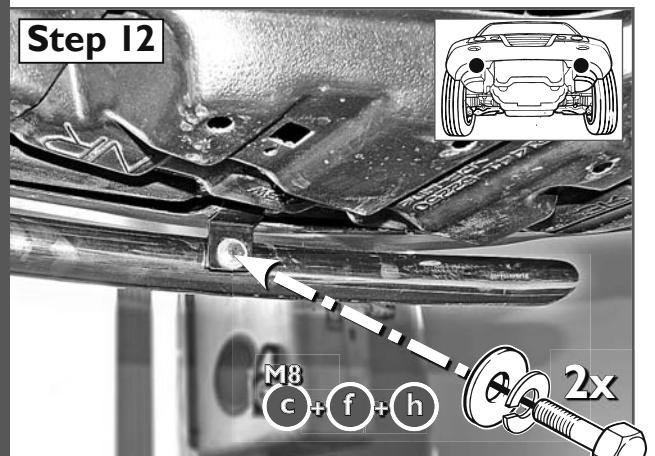
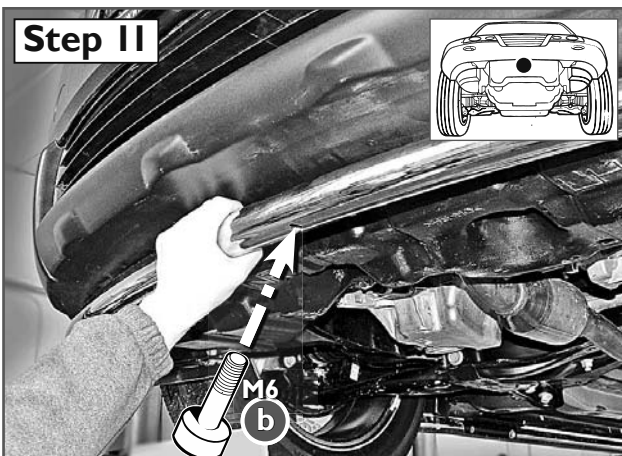
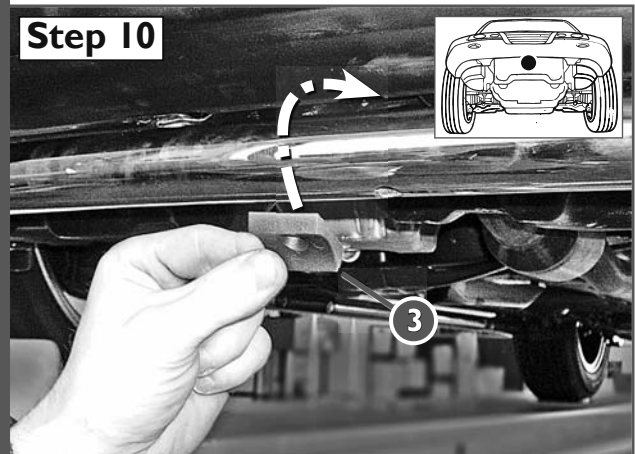
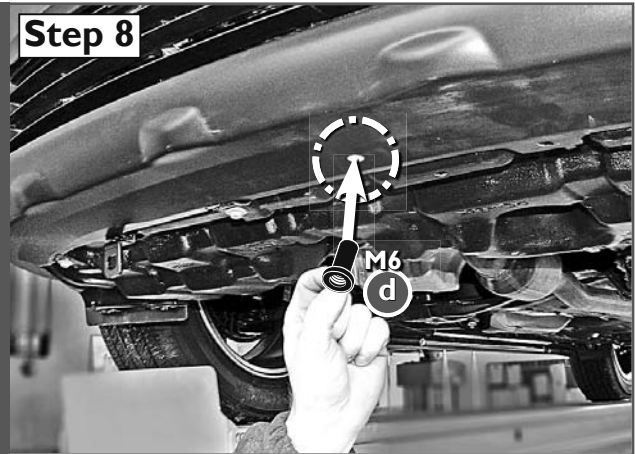
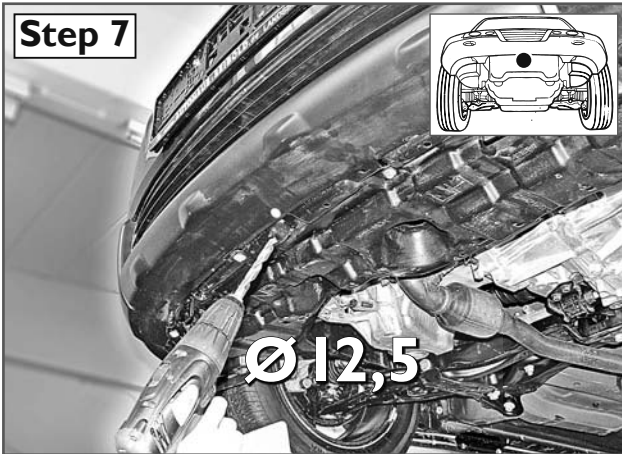



if combined with  
14N4013 or 14N4113

